

TC22 and TC27 Accessories Guide

The ultimate cost-effective
tool for small businesses —
with big business features

Revised May 2023



I.	Accessories that POWER devices	
1	Cradles	
1.1	Single-slot chargers	3
1.2	Multi-slot chargers	4
1.3	Conversion kits	5
1.4	Mounting options for chargers	6
2	Batteries	
2.1	NEW: Spare Li-ion batteries with BLE Beacon	6
2.2	Spare Li-ion batteries	7
2.3	Spare battery chargers	7
3	Power supply, cables, and adapters	
3.1	Power supply and cable matrix	8
3.2	Country-specific AC line cords	9
II.	Accessories that ENABLE productivity solutions	
4	Headsets	
4.1	Wired headsets and accessories for Workforce Connect	11
4.2	Wired headsets and accessories for voice-directed picking	12
4.3	Wireless headsets and accessories for voice-directed picking	12
4.4	Cables and adaptors	13
5	Wearable mounts and other accessories	
5.1	Arm/Wrist mounts	14
5.2	Replacement straps	15
5.3	Replacement straps & hand straps	16
6	Trigger handles	
6.1	NEW: Electronic trigger handle	17
III.	Accessories that PROTECT devices	
8	Soft holsters, rugged boots, and screen protectors	
8.1	Holsters, rugged boots, and screen protectors	18

Cradles



Single-slot charger

SKU# [CRD-TC2L-BS1CO-01](#)

Single-slot charge-only cradle. Charges a single device.

- Charges Standard Capacity battery from 0 to 80% in less than 1 hours 20 minutes.
- Charges Extended Capacity battery from 0 to 80% in less than 1 hours 50 minutes.
- Compatible with TC22 / TC27 units with Hand Straps, Trigger Handle or Protective boot when shim is removed.
- Includes: Shim for use with TC22 / TC27 without Rugged Boot. Remove the shim for compatibility with TC22 / TC27 with Rugged Boot / Trigger Handle.
- Sold separately: Single-slot cradle requires power supply [SKU# PWR-WUA5V12W0XX](#) (last XX of SKU are country-specific) and USB-C cable [SKU# CBL-TC5X-USBC2A-01](#).



Single-slot USB capable charger

SKU# [CRD-TC2L-SE1ET-01](#)

Single-slot charger and USB cradle. Charges a single device.

- Charges Standard Capacity battery from 0 to 80% in less than 1 hour 20 minutes.
- Charges Extended Capacity battery from 0 to 80% in less than 1 hour 50 minutes.
- Compatible with TC22 / TC27 units with Hand Straps, Trigger Handle or Protective boot when shim is removed.
- Includes: Shim for use with TC22 / TC27 without Rugged Boot. Remove the shim for compatibility with TC22 / TC27 with Rugged Boot / Trigger Handle.
- Sold separately: Power supply [SKU# PWR-BGA12V50W0WW](#), DC cable [SKU# CBL-DC-388A1-01](#), and country-specific AC line cord (listed later in this document). To charge and sync using USB port with a computer, purchase USB cable [SKU# 25-124330-01R](#). To connect to Ethernet, purchase USB-to-Ethernet module [SKU# MOD-MT2-EU1-01](#) with bracket [SKU# BRKT-TC51-ENET1-02](#).



Single-slot charger plus battery

SKU# [CRD-TC2L-BS11B-01](#)

Single-slot charger plus battery charger. Charges a single device and any TC22 / TC27 spare Li-Ion battery.

- Charges Standard battery in device from 0 to 80% in less than 1 hour 20 minutes.
- Charges Extended battery in device from 0 to 80% in less than 1 hour 50 minutes.
- Charges Standard/Extended spare battery from 0-90% in less than 4 hours.
- Compatible with TC22 / TC27 units with Hand Strap, Trigger Handle, or Protective boot when shim is removed.
- Includes: Shim for use with TC22 / TC27 without Rugged Boot. Remove the shim for compatibility with TC22 / TC27 with Rugged Boot / Trigger Handle.
- Sold separately: Power supply [SKU# PWR-BGA12V50W0WW](#), DC cable [SKU# CBL-DC-388A1-01](#), and country-specific AC line cord (listed later in this document).



Cradles

Five-slot charger

SKU# CRD-TC2L-BS5CO-01

- Will charge up to five TC22 / TC27 devices.
- Charges Standard Capacity battery from 0 to 80% in less than 1 hour 20 minutes.
- Charges Extended Capacity battery from 0 to 80% in less than 1 hour 50 minutes.
- Compatible with TC22 / TC27 units with hand strap or Trigger Handle attached (and shim removed).
- Can be rack-mounted in a standard 19-inch server rack via mounting bracket [SKU# BRKT-SCRD-SMRK-01](#).
- Sold separately: Power supply [SKU# PWR-BGA12V108W0WW](#), DC cable [SKU# CBL-DC-381A1-01](#), and country-specific AC line cord (listed later in this document).

5-Slot ethernet cradle

SKU# CRD-TC2L-SE5ET-01

- Allows network speeds up to 1Gbps.
- Connects to USB-C connector and 2-pin charge contacts on bottom of TC22/TC27.
- Will charge up to five TC22 / TC27 units.
- Charges Standard Capacity battery from 0 to 80% in less than 1 hour 20 minutes.
- Charges Extended Capacity battery from 0 to 80% in less than 1 hour 50 minutes.
- Compatible with TC22 / TC27 units with hand strap or Trigger Handle attached.
- Can be rack-mounted in a standard 19-inch server rack via mounting bracket [SKU# BRKT-SCRD-SMRK-01](#).
- Sold separately: Power supply [SKU# PWR-BGA12V108W0WW](#), DC cable [SKU# CBL-DC-381A1-01](#), and country-specific AC line cord (listed later in this document).

Cradles

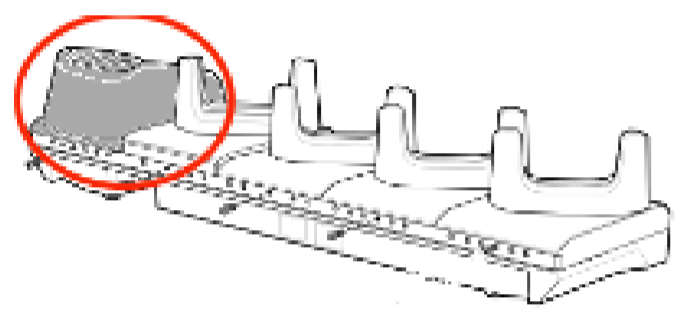

Battery charger replacement kit

SKU# CRDCUP-TC2L4B-01

4-slot battery charger replacement cup

- Used to replace a legacy TC21 / TC26 series 4-slot Battery Charger on single-slot or multi-slot ShareCradle base when migrating from TC21 / TC26 to TC22 / TC27.
- No more than one cup shall be installed on a multi-slot ShareCradle base when converting with this 4-slot Battery Charger cup.
- Should replace the TC21/TC26 toaster cup in the same location on the ShareCradle base, usually the left-most slot when facing the cradle.

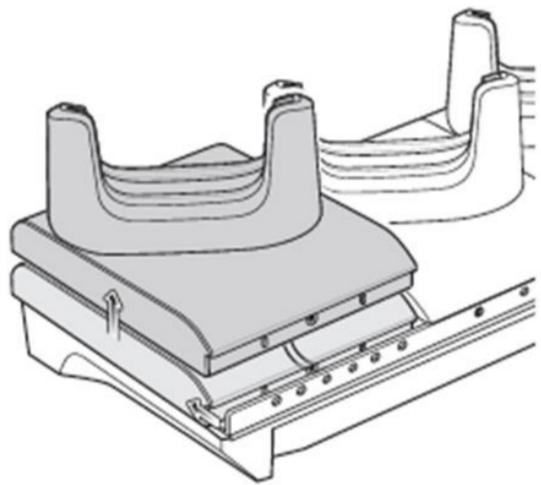

Device cradle cup replacement kit

SKU# CRDCUP-TC2L5C-01

Kit allows the conversion of other devices' 5-Slot Charge-Only ShareCradles purchased after 2019 to support TC22 / TC27.

- Only compatible with cradles that use ShareCradle design.
- Kit includes five TC22 / TC27 ShareCradle cups.
- Not all five cups need to be used, therefore creating a multi-slot cradle supporting a mixed combination of devices (e.g., two TC22 / TC27 and three TC5X devices).

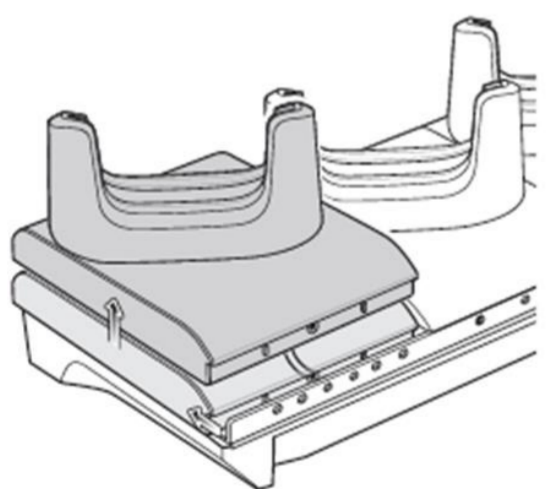

Device cradle cup replacement kit

SKU# CRDCUP-TC2L5E-01

Kit allows the conversion of other devices' 5-Slot Charge + Communication ShareCradles purchased after 2019 to support TC22 / TC27.

- Only compatible with cradles that use ShareCradle design.
- Kit includes five TC22 / TC27 ShareCradle cups and shims.
- Not all five cups need to be used, therefore creating a multi-slot cradle supporting a mixed combination of devices (e.g., two TC22 / TC27 and three TC5X devices).

Mounting options for chargers



Rack mounting for space optimization

Optimize available space by mounting any set of five-slot chargers for TC22 / TC27 on a standard, 19-inch server rack.

- Ideal for customers that have several devices per location.
- Compatible with all five-slot chargers for TC22 / TC27.



Mounting bracket

SKU# BRKT-SCRD-SMRK-01

Use five-slot ShareCradle mounting bracket to attach five-slot TC22 / TC27 cradles to the wall or mount on a 19-inch server rack.

- Offers cable routing slots and removable tray that stores / conceals power supply.
- Adjustable orientations:
 - 25° angle for high-density (five-slot chargers).
 - Horizontal (single-slot or four-slot spare Li-ion charger).

Spare Li-ion batteries

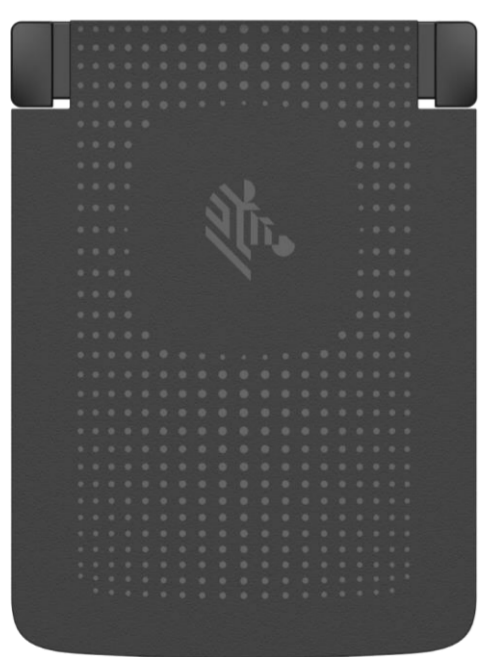

NEW: Standard Power Precision Li-ion Battery w/ BLE Beacon

SKU# BTRY-TC2L-2XMAXB-01

TC22 / TC27 Standard PowerPrecision Li-Ion Battery with BLE Beacon — 3800 mAh.

- Premium-grade battery cells with longer lifecycle and tested to meet rigorous controls and standards.
- BLE beacon allows device with this battery to be located even if powered off using [Zebra Device Tracker](#).
- Sold separately: Zebra Device Tracker licenses for either 1-year SKU# SW-BLE-DT-SP-1YR or 3-years SKU# SW-BLE-DT-SP-3YR.

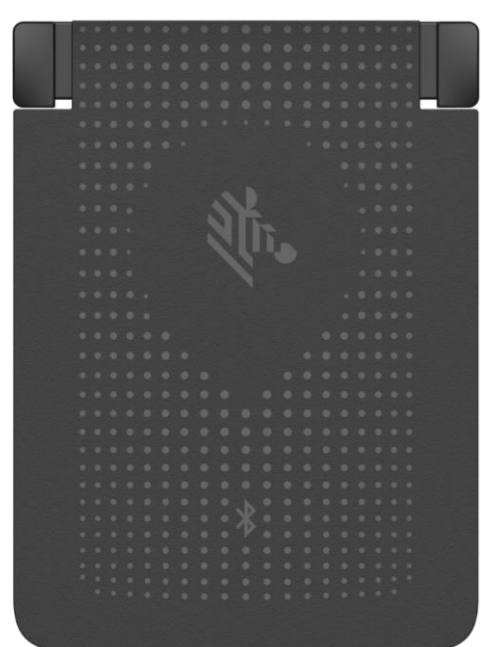

Standard Power Precision Li-ion Battery

SKU# BTRY-TC2L-2XMAXX-01

TC22 / TC27 Standard PowerPrecision Li-ion Battery — 3800 mAh.

- Premium-grade battery cells with longer lifecycle and tested to meet rigorous controls and standards.



Extended PowerPrecision Li-ion Battery

SKU# BTRY-TC2L-3XMAXX-01

TC22 / TC27 Extended PowerPrecision Li-ion Battery — 5200 mAh

- Premium-grade battery cells with longer lifecycle and tested to meet rigorous controls and standards.

Spare battery charger



Battery Charger

SKU# SAC-TC2L-4SCHG-01

- Spare battery charger to charge any four Li-ion batteries.
- Standard and Extended capacity batteries will charge from 0–90% in less than 4 hours.
- Can be used standalone or up to 4 chargers can be mounted on Mounting Bracket
SKU# BRKT-SCRD-SMRK-01.
- Sold separately: Power Supply SKU# PWR-BGA12V50W0WW, DC Cable SKU# CBL-DC-388A1-01, and Country-specific AC Line cord (listed later in this document).



Mounting Bracket for Battery Chargers

SKU# BRKT-SCRD-SMRK-01

- Four 4-slot spare battery chargers can be mounted as shown with mounting bracket.
- Use to mount to wall or with standard 19-inch server rack for more density and save space.

Power supply, cables, and adaptors

Power supply and cable matrix













SKU#	Description	Note
PWR-BGA12V108W0WW	Level VI AC/DC power supply brick. AC Input: 100–240V, 2.8A. DC Output: 12V, 9A, 108W.	Sold separately. Use for: <ul style="list-style-type: none"> • CRD-TC2L-BS5CO-01 • CRD-TC2L-SE5ET-01
CBL-DC-381A1-01	DC line cord for running multi-slot cradles from a single Level VI power supply.	
PWR-BGA12V50W0WW	Level VI AC/DC power supply brick. AC Input: 100-240V, 2.4A. DC Output: 12V, 4.16A, 50W.	Sold separately. Use for: <ul style="list-style-type: none"> • CRD-TC2L-SE1ET-01 • CRD-TC2L-BS11B-01 • SAC-TC2L-4SCHG-01
CBL-DC-388A1-01	DC line cord for running single-slot cradles or battery chargers from a single Level VI power supply.	
CBL-TC5X-USBC2A-01	USB C to USB A communications and charging cable, 1m long	Sold separately. Use to: <ul style="list-style-type: none"> • Directly charge TC22 / TC27 using a wall wart • Connect TC22 / TC27 to a computer (developer tools) • Charge TC22 / TC27 in a vehicle (can be used with cigarette light adapter SKU# CHG-AUTO-USB1-01, if needed)
CBL-TC2Y-USBC90A-01	USB C to USB A cable with 90° bend in USB-C adapter	
25-124330-01R	Micro USB active-sync cable for use with Single Slot USB/Communication Cradle.	Sold separately. Required for use with SKU# CRD-TC2L-SE1ET-01 if syncing with a computer is desired while TC22 / TC27 is in the charger.
CBL-DC-523A1-01	DC Y-line cord for running two 4-slot battery chargers to a single Level VI power supply SKU# PWR-BGA12V108W0WW .	Sold separately. Use to: Consolidate power supplies for multiple spare battery chargers proximally placed to each other.
PWR-WUA5V12W0XX	USB type A power supply adaptor (wall wart). Replace 'XX' in SKU as follows to get the right plug style based on region: US (United States) • GB (United Kingdom) • EU (European Union) AU (Australia) • CN (China) • IN (India) • KR (Korea) • BR (Brazil)	Sold separately. Use with a communications & charge cable to directly charge TC22 / TC27 device drawing power from a wall socket.

Accessories that power devices



Power supply, cables, and adaptors

Country-specific AC line cords: grounded, 3-prong

SKU#	Country / region	Note	
23844-00-00R	North America (United States, Canada, Mexico)	7.5 feet long Commonly used with chargers mounted in server racks	
50-16000-678R	North America (United States, Canada, Mexico)	3 feet long	
50-16000-221R	North America (United States, Canada, Mexico)	6 feet long	
50-16000-727R	Brazil	1.8 meters (6 feet) long	
50-16000-680R	Argentina	1.8 meters (6 feet) long	
50-16000-217R	American Samoa, Australia, New Guinea	1.8 meters (6 feet) long	
50-16000-218R	Japan	1.8 meters (6 feet) long	
50-16000-219R	Antigua, Bermuda, Burma, Channel Islands, Hong Kong, Iraq, Ireland, Malaysia, North Ireland, Scotland, Singapore, United Kingdom, Wales	1.8 meters (6 feet) long	
50-16000-257R	China	1.8 meters (6 feet) long	
50-16000-220R	Europe, Abu Dhabi, Bolivia, Dubai, Egypt, Iran, Korea, Russia, Vietnam	1.8 meters (6 feet) long	
50-16000-671R	Italy	1.8 meters (6 feet) long	
50-16000-669R	India, S. Africa, Africa	1.8 meters (6 feet) long	

[Back to Table of Contents](#)

Accessories that power devices



Power supply, cables, and adaptors

Country-specific AC line cords: ungrounded, 2-prong

SKU#	Country / region	Note
50-16000-182R	United States	Type A NEMA 1-15 plug
50-16000-255R	Europe, Abu Dhabi, Bolivia, Dubai, Egypt, Iran, Korea, Russia, Vietnam.	Type C CEE7/16 plug
50-16000-670R	Bermuda, Hong Kong, Iraq, Ireland, Malaysia, Singapore, United Kingdom.	



Accessories that enable productivity solutions



Headsets

Close gaps, Open possibilities with Workforce Connect

Usher in a new era of transformation—one led by your frontline and powered by Zebra Workforce Connect. One where communication and information flows freely and gaps between teams, workflows and data are closed.

With Workforce Connect, hindered workers become effective problem solvers, contributing their best. Critical workflows are streamlined in one place, on one device, equipping workers with the information they need, right at their fingertips.

Only Zebra offers the most complete lineup of software and rugged hardware with the scalability, support and service needed to make the greatest impact where it counts—on the frontline.

[Learn more about you can elevate your frontline workers with Zebra Workforce Connect.](#)



Wired headsets for Workforce Connect

SKU# HDST-USBC-PTT1-01

PTT headset with USB-C connector; one-piece solution.

- For Push-To-Talk (PTT) applications with volume up/volume down/PTT buttons. Compatible with PTT Express/PTT Pro.
- Rotating earpiece allows for right or left ear configuration. Mono headset with microphone.
- Includes clip for attaching PTT button to clothing.



Wired headsets for Workforce Connect

SKU# HDST-35MM-PTVP-02

PTT and VoIP headset with 3.5mm standard jack.

- For Push-To-Talk (PTT) and VoIP telephony. Compatible with PTT Express/PTT Pro.
- Rotating earpiece allows for right or left ear configuration. Mono headset with microphone.
- Includes clip for attaching PTT button to clothing.
- Requires adapter [SKU# ADP-USBC-35MM1-01](#).

Headsets

Rugged Bluetooth and corded HD voice headsets for the most demanding industrial environments

When it comes to enabling speech-driven applications and voice communications in warehouses, manufacturing plants and outdoor yards, you need a headset that is specially designed for the job. The HS3100 Bluetooth and HS2100 corded headsets are loaded with features that offer everything you need in an industrial headset.

[Learn more about how these headsets deliver a superior voice experience.](#)

Wired headsets for voice-directed picking

HS2100 rugged wired headset

Corded HD voice headset. Can be used with TC22/TC27 devices with adapters [SKU# CBL-HS2100-3MS1-01](#) and [SKU# ADP-USBC-35MM1-01](#).

- Dustproof, spray proof, and waterproof.
- Noise cancellation for a superior voice experience in the noisiest environments.
- Swiveling boom mutes microphone allowing user to prevent voice pick applications from recognizing non-voice pick conversations.
- Feather-light for extraordinary comfort.



SKU#	Description
HS2100-OTH	HS2100 Rugged Wired Headset Over-The-Head Headband includes HS2100 Boom Module and HSX100 OTH Headband Module
HS2100-BTN-L	HS2100 Rugged Wired Headset (Behind-the-neck headband left)
HS2100-OTH-SB	HS2100 Rugged Wired Headset (Over-the-head headband) includes HS2100 Shortened Boom Module and HSX100 OTH headband module
HS2100-BTN-SB	HS2100 Rugged Wired Headset (Behind-the-neck headband left) includes HS2100 Shortened Boom Module and HSX100 BTN headband module

Wireless headsets for voice-directed picking

HS3100 rugged Bluetooth headset

Bluetooth headset for voice-directed picking applications.

- Noise cancellation tuned for Voice-Directed Picking applications.
- Swap batteries on the fly — without losing the Bluetooth connection.
- Split-second tap-to-pair simplicity using NFC. 15 hours of battery



SKU#	Description
HS3100-OTH	HS3100 Rugged Wired Headset Over-The-Head Headband includes HS3100 Boom Module and HSX100 OTH Headband Module
HS3100-BTN-L	HS3100 Rugged Wired Headset (Behind-the-neck headband left)
HS3100-OTH-SB	HS3100 Rugged Wired Headset (Over-the-head headband) includes HS3100 Shortened Boom Module and HSX100 OTH headband module
HS3100-BTN-SB	HS3100 Rugged Wired Headset (Behind-the-neck headband left) includes HS3100 Shortened Boom Module and HSX100 BTN headband module
HS3100-SBOOM-01	HS3100 Shortened Boom Module (includes microphone boom, battery and windscreen)

Accessories that enable productivity solutions



Cables and adapters



Cradle to USB cable

SKU# 25-124330-01R

Single slot cradle to PC/host USB cable.

- Used with single-slot cradle.
- Micro-USB connection on cradle end.



Adapter cable

SKU# CBL-HS2100-3MS1-01

HS2100 headset standard cable – 3.5mm jack.

- 3.5mm barrel jack connector with cable length 43" (1.1m)
- For use with TC22 / TC27 or other devices using a 3.5mm barrel jack audio connector. Requires [SKU# ADP-USBC-35MM1-01](#).
- Rugged cable with rugged connectors that are keyed/collared for a locking failsafe connection.
- Includes one clothing clip. Additional clips can be purchased separately.



Adapter cable

SKU# ADP-USBC-35MM1-01

USB-C to 3.5mm Adapter Cable

- Allows headsets with 3.5mm jack to be connected to TC22/TC27
- Adapter provides PTT button, volume up/volume down buttons.
- Adapter cable length is about 2.5ft. (78cm)
- Clip on rear of adapter allows cable to be wrapped for length management
- PTT button functionality tested with headset [SKU# HDST-35MM-PTVP-02](#) - Both the PTT button the headset and the adapter may be used.



Wearable mounts and other accessories

Arm Mount

SKU# SG-TC2L-ARMNT-01

Size Medium

- Enables the TC22 / TC27 to be mounted to the arm for hands free operation.
- Mount allows TC22 / TC27 to function as a hands-free solution in combination with the RS5100 / RS6100 (or similar) ring scanner.
- Compatible with Standard or Extended Capacity battery.
- Not compatible with Rugged Boot.
- Includes: Medium sized (300mm) Velcro wrist strap [SKU# SG-TC2L-ARMSTRAP-01](#) and carrier comfort pad [SKU# SG-TC2L-CMPD-01](#)

Arm Mount

SKU# SG-TC2L-ARMNT-02

Size Large

- Enables the TC22 / TC27 to be mounted to the arm for hands free operation.
- Mount allows TC22 / TC27 to function as a hands-free solution in combination with the RS5100 / RS6100 (or similar) ring scanner.
- Compatible with Standard or Extended Capacity battery.
- Not compatible with Rugged Boot.
- Includes: Large sized (330mm) Velcro wrist strap [SKU# SG-TC2L-ARMSTRAP-02](#) and carrier comfort pad [SKU# SG-TC2L-CMPD-01](#)

Wrist Mount

SKU# SG-TC2L-WMADP1-02

- Wrist mount with extended BOA dial-to-fit wrist strap
- Swivel design allows device to be viewed in portrait or landscape mode enabling hands-free functionality.
- Velcro-free design uses non-absorbent materials that can be wiped down.
- Strap length can be adjusted between 164 to 265mm (approx. 6.5 to 10.5")
- Not compatible with Rugged Boot.
- Includes: Carrier, Comfort Pad [SKU# SG-TC2L-CMPD-01](#) and Medium/Large sized Wrist Strap [SKU# SG-NGWT-WSTPLN-01](#)

Wearable mounts and other accessories



BOA Replacement Strap

SKU# SG-NGWT-WSTPST-01

Replacement wrist strap – standard size.

- White dial and accent color on strap identify size as standard (small/medium).
- Strap length can be adjusted between 128 to 191mm (approx. 5.0 to 7.5").



BOA Replacement Straps

SKU# SG-NGWT-WSTPLN-01

Replacement wrist strap – extended size.

- Black dial and accent color on strap identify size as extended (medium/large).
- Strap length can be adjusted between 164 to 265mm (approx. 6.5 to 10.5").



Velcro Replacement Strap

SKU# SG-TC2L-ARMSTRAP-01

Replacement arm strap – size standard

- Replaces the Velcro strap included for SKU# SG-TC2L-ARMNT-01
- Comes in size medium with strap length of 300mm or 12"

Accessories that enable productivity solutions



Wearable mounts and other accessories



Velcro Replacement Strap

SKU# SG-TC2L-ARMSTRAP-02

Replacement arm strap – size large

- Replaces the Velcro strap included for SKU# SG-TC2L-ARMNT-02
- Comes in size large with strap length of 330mm or 13"



Hand straps

SKU# SG-TC2L-HSTRP1-01

Hand strap.

- Allows device to be easily held in palm of hand.
- Attaches directly to device, even with rugged boot installed.
- Sold separately: Rugged boot SKU# SG-TC2L-BOOT-01.

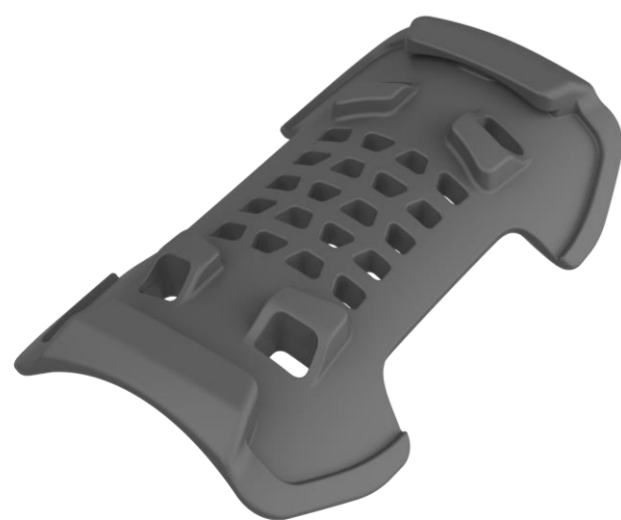

Replacement Comfort Pad

SKU# SG-TC2L-CMPD-01

Comfort Pad for Arm Mount

- Replaces the Comfort Pad included on either SKU# SG-TC2L-ARMNT-01 or SKU# SG-TC2L-ARMNT-02 or SKU# SG-TC2L-WMADP1-02
- Soft Rubber material
- Easily removable and hygienic

Trigger handles and accessories



Electronic Trigger Handle

SKU# TRG-TC2L-SNP1-01

Pistol-grip trigger handle.

- Uses electrical trigger via contacts on back side of TC22 / TC27.
- Trigger handle accessory offers customers the option of using the product in a gun form factor, ideal for scan-intensive operations.
- Requires rugged boot [SKU# SG-TC2L-BOOT-01](#).
- Does not block access to rear facing camera and flash allowing camera to be used while using the trigger handle.
- Compatible with both standard and extended capacity batteries.
- Not compatible with Hand Strap,



Wrist Strap

SKU# 50-12500-066

- Attaches to bottom of Snap-on Trigger Handle ([SKU# TRG-TC2L-SNP1-01](#)).

Soft holsters, rugged boots, and screen protectors



Soft holster

SKU# SG-TC2L-HLSTR1-01

Soft holster.

- Vertical orientation with open bucket design to accommodate TC22 / TC27 with optional trigger handle [SKU# TRG-TC2L-SNP1-01](#) .
- Compatible with rugged boot [SKU# SG-TC2L-BOOT-01](#) and hand strap [SKU# SG-TC2L-HSTRP1-01](#).
- Opening at bottom of holster for providing drainage and route for audio from device's speaker.
- Nonrotating for maximum durability.
- Compatible with devices using Standard or Extended Capacity battery.



Rugged boot

SKU# SG-TC2L-BOOT-01

- Boot increases drop spec of device to 5 ft. (1.5 m) and drop surface to concrete.
- Compatible with devices using Standard or Extended Capacity battery.
- Compatible with Hand Strap.



Screen protectors

SKU# SG-TC2L-SCRNPT1-01

Screen protector.

- Tempered glass.
- Includes: Alcohol wipes, cleaning cloth, and instructions needed for screen protector installation.